

REV	ECN	REVISION HISTORY	DATE	APPROVED
A	XXXXXX	RELEASE	5/9/1957	DR
B	F120091	REDRAWN CAD, WAS C SIZE GROUP DRAWING	9/19/2012	dmjohnson
C	F130052	ROTATE ROCKER CUPS 30 DEG	4/5/2013	dmjohnson

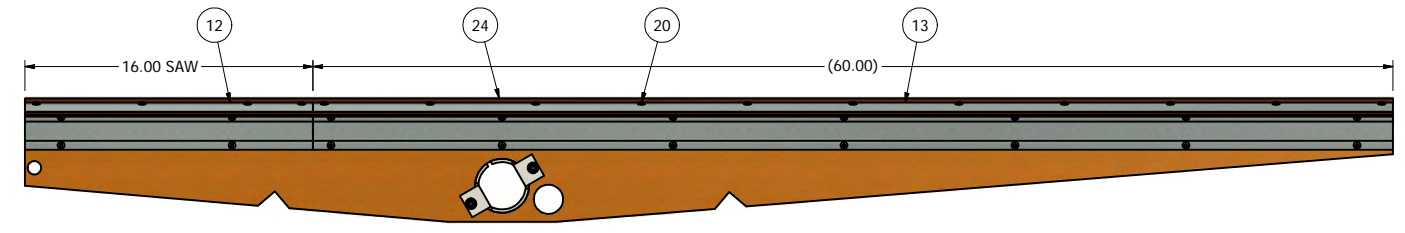

STEP 2: RIGHT ROCKER SIDE ASSEMBLY, LEFT SIDE VIEW  
 TYPICAL ASSEMBLY FOR LEFT ROCKER SIDE

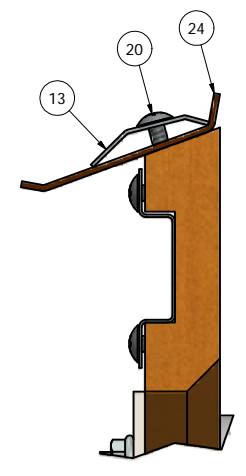
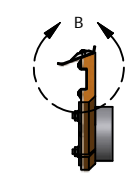

DETAIL B  
 SCALE 1:1

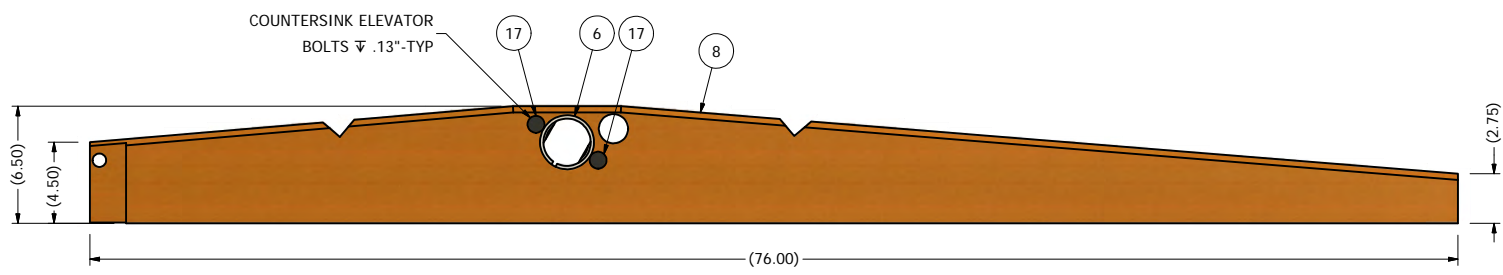

STEP 1: RIGHT ROCKER SIDE ASSEMBLY, LEFT SIDE VIEW  
 TYPICAL ASSEMBLY FOR LEFT ROCKER SIDE

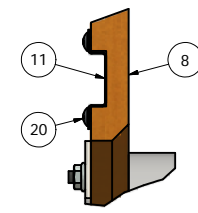

DETAIL A  
 SCALE 1/2

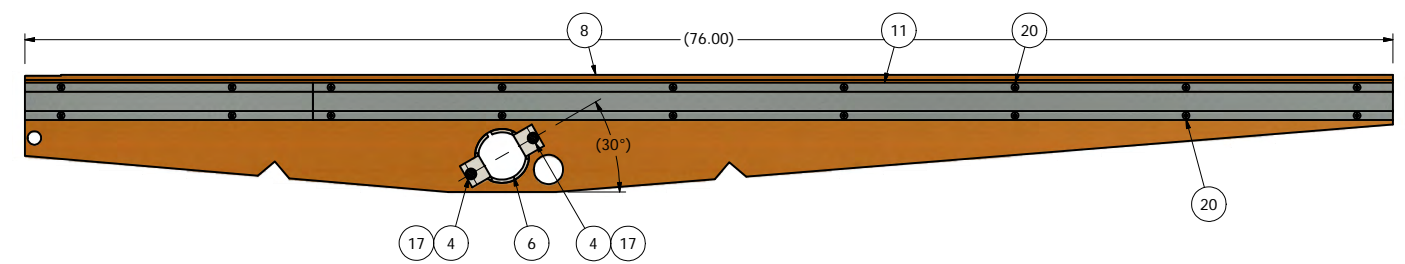
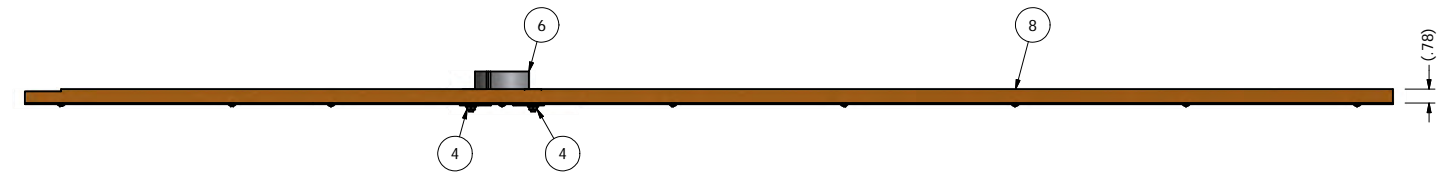

ITEM	PART NUMBER	QTY	DESCRIPTION
24	F91152006	13.000 ft	BELTING, 3 PLY FSXFS 2.50 X 78.00"
23	F90005303	1	GIRT WLDMT, ROCKER ADJ, TELESCOPING, #8
22	F84212122	8	SMS, FLT X HD #8 X 3/4"
21	F83453403	4	SMS, PAN X HD, #10 X 3/4"
20	F83453402	68	SMS, PAN X HD, #8 X 3/4"
19	F83451201	7	SMS, PAN X HD, #8 X 1/2"
18	F83440301	4	SMS, FLAT CROSS HEAD #10 X 1.50"
17	F82021407	4	BOLT, ELEV 1/4-20 X 1.25"
16	F11302510	1	COVER, APRON, ADJ GIRT, ROCKER, #8
15	F03806000	2	ANGLE, SCREEN STOP, ROCKER
14	F03803303	1	BLANK ASSY, BTM ROCKER, BTM SHOE, SX298D
13	F03801100	2	CAP, RUBBER HOLDING, ROCKER, 60.00"
12	F03801100	2	CAP, RUBBER HOLDING, ROCKER, 16.00"
11	F03800412	2	LINER WLDMT, SCREENWAY, ROCKER, 76.00"
10	F03800002	2	BRACE, BOTTOM, ROCKER, #8
9	F03601505	1	SIDE, LH, BTM ROCKER 76", BTM SHOE, SX29D/SX298D
8	F03601504	1	SIDE, RH, BTM ROCKER 76", BTM SHOE, SX29D/SX298D
7	F03500800	2	SCREEN HOOK ASSY, STANDARD
6	F03500600	2	CUP WLDMT, ROCKER, HEAVY DUTY BRUSH
5	F03310009	1	GRAIN STOP ASSY, ROCKER, 2.50" X #8
4	66783300	4	NUT, HEX SERR LOCK 1/4-20
3	66782600	4	NUT, HEX SERR LOCK 10-24
2	66402200	7	WASHER, FLAT, #8
1	60282626	4	BOLT, CARR 10-24 X 1.25"

**CLIPPER**  
SEPARATION TECHNOLOGIES  
SINCE 1988

**DIVISION OF**  
**A.T.FERRELL COMPANY**  
 1440 S ADAMS ST  
 BLUFFTON, INDIANA  
 46714 - USA  
 PH: 260-824-3400  
 FAX: 260-824-5463

This drawing is the property of the A.T. Ferrell Company, Inc and must be returned immediately upon request. No part of this drawing may be reproduced, stored in a retrieval system or transmitted in any form or by any means, without prior written consent of the A.T. Ferrell Company, Inc.

TOLERANCES EXCEPT AS NOTED	TITLE:
DECIMAL: .030	ROCKER ASSY, BOTTOM, BOTTOM SHOE, SX298D
FRACTIONAL: 1/32	
XX ± .030	FINISH:
XXX ± .005	NONE
XXXX ± .001	ANGULAR: ± 1/2°
	NONE
<b>CAD</b>	SCALE: 0.19:1
NO MANUAL CHANGES	SHEET: 1 OF 3
	SIZE: D
	PART NUMBER: F03502010
	REV: C

- NOTES:
- DO NOT SCALE FROM DRAWING.
  - ONE PIECE REQUIRED PER F03013208/09: SHOE ASSY, RH/LH ADJ PITCH BOTTOM, SX298D.
  - ONE PIECES REQUIRED PER F03018407/08: SHOE ASSY, RH/LH ADJ PITCH BOTTOM, SX2968D.

REV	ECN	REVISION HISTORY	DATE	APPROVED
A	XXXXXX	RELEASE	5/9/1957	DR
B	F120091	REDRAWN CAD, WAS C SIZE GROUP DRAWING	9/19/2012	dmjohnson
C	F130052	ROTATE ROCKER CUPS 30 DEG	4/5/2013	dmjohnson

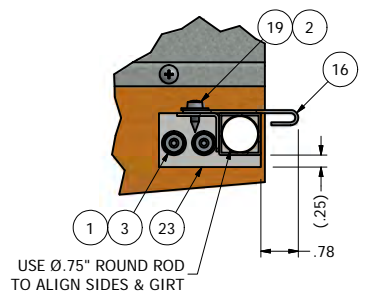
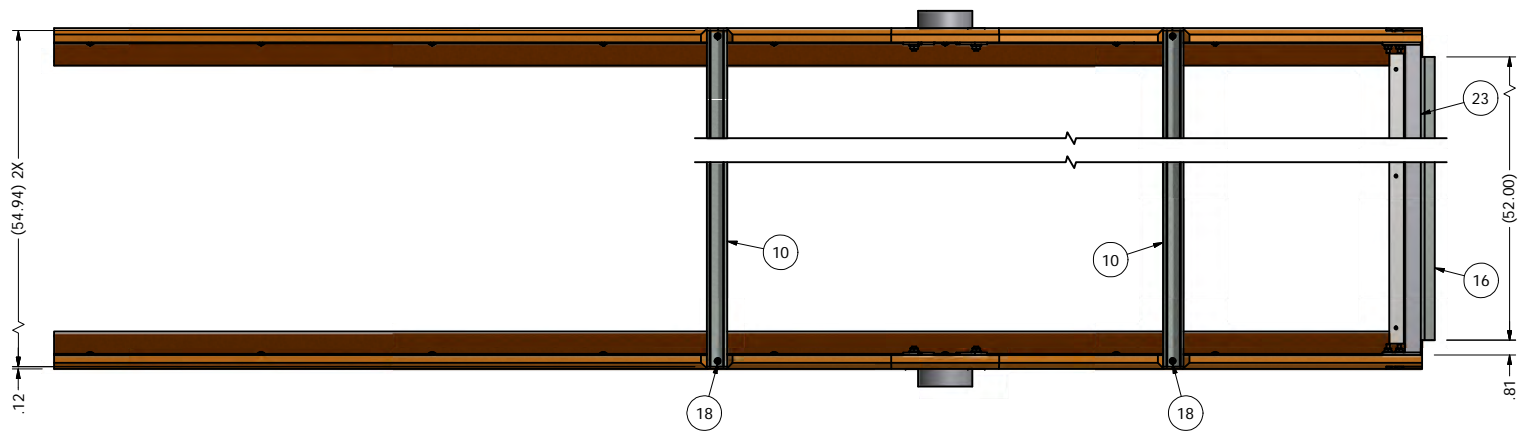

DETAIL D  
SCALE 1/2

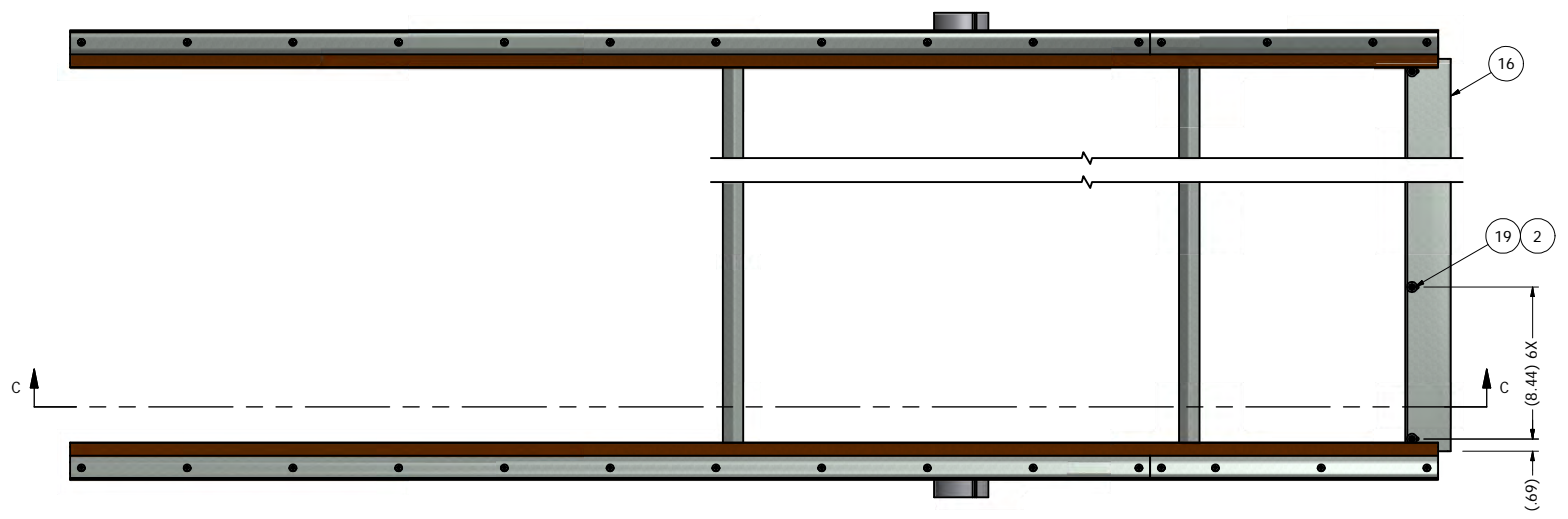
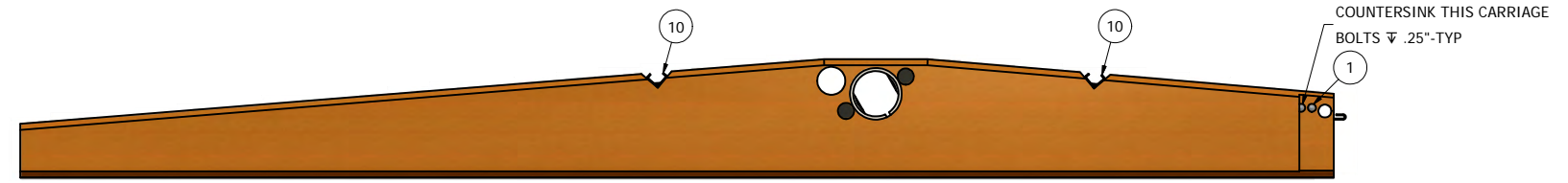
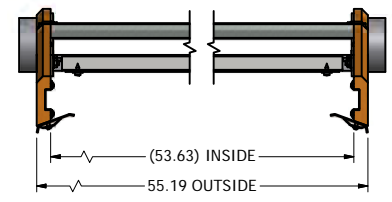

STEP 3: GIRT INSTALLATION, TOP VIEW

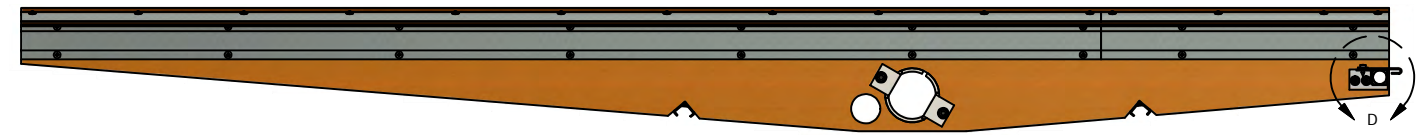

SECTION C-C

ITEM	PART NUMBER	QTY	DESCRIPTION
24	F91152006	13.000 ft	BELTING, 3 PLY FSXFS 2.50 X 78.00"
23	F90005303	1	GIRT WLDMT, ROCKER ADJ, TELESCOPING, #8
22	F84212122	8	SMS, FLT X HD #8 X 3/4"
21	F83453403	4	SMS, PAN X HD, #10 X 3/4"
20	F83453402	68	SMS, PAN X HD, #8 X 3/4"
19	F83451201	7	SMS, PAN X HD, #8 X 1/2"
18	F83440301	4	SMS, FLAT CROSS HEAD #10 X 1.50"
17	F82021407	4	BOLT, ELEV 1/4-20 X 1.25"
16	F11302510	1	COVER, APRON, ADJ GIRT, ROCKER, #8
15	F03806000	2	ANGLE, SCREEN STOP, ROCKER
14	F03803303	1	BLANK ASSY, BTM ROCKER, BTM SHOE, SX298D
13	F03801100	2	CAP, RUBBER HOLDING, ROCKER, 60.00"
12	F03801100	2	CAP, RUBBER HOLDING, ROCKER, 16.00"
11	F03800412	2	LINER WLDMT, SCREENWAY, ROCKER, 76.00"
10	F03800002	2	BRACE, BOTTOM, ROCKER, #8
9	F03601505	1	SIDE, LH, BTM ROCKER 76", BTM SHOE, SX29D/SX298D
8	F03601504	1	SIDE, RH, BTM ROCKER 76", BTM SHOE, SX29D/SX298D
7	F03500800	2	SCREEN HOOK ASSY, STANDARD
6	F03500600	2	CUP WLDMT, ROCKER, HEAVY DUTY BRUSH
5	F03310009	1	GRAIN STOP ASSY, ROCKER, 2.50" X #8
4	66783300	4	NUT, HEX SERR LOCK 1/4-20
3	66782600	4	NUT, HEX SERR LOCK 10-24
2	66402200	7	WASHER, FLAT, #8
1	60282626	4	BOLT, CARR 10-24 X 1.25"

**CLIPPER** SEPARATION TECHNOLOGIES SINCE 1988

**DIVISION OF**  
 A.T.FERRELL COMPANY  
 1440 S ADAMS ST  
 BLUFFTON, INDIANA  
 46714 - USA  
 PH: 260-824-3400  
 FAX: 260-824-5463

This drawing is the property of the A.T. Ferrell Company, Inc and must be returned immediately upon request. No part of this drawing may be reproduced, stored in a retrieval system or transmitted in any form or by any means, without prior written consent of the A.T. Ferrell Company, Inc.

DRAWN BY: dmjohnson  
 DRAWN DATE: 9/19/2012  
 APPROVED BY: DMJ

TOLERANCES EXCEPT AS NOTED	DECIMAL: XX ± .030 XXX ± .005 XXXX ± .001	FRACTIONAL: ± 1/32 ANGULAR: ± 1/2°	TITLE: ROCKER ASSY, BOTTOM, BOTTOM SHOE, SX298D
CAD NO MANUAL CHANGES	SCALE: 0.19:1	SHEET: 2 OF 3	SIZE: D
		PART NUMBER: F03502010	REV: C

- NOTES:  
 1. DO NOT SCALE FROM DRAWING.  
 2. ONE PIECE REQUIRED PER F03013208/09: SHOE ASSY, RH/LH ADJ PITCH BOTTOM, SX298D.  
 3. ONE PIECES REQUIRED PER F03018407/08: SHOE ASSY, RH/LH ADJ PITCH BOTTOM, SX2968D.

REVISION HISTORY				
REV	ECN	DESCRIPTION	DATE	APPROVED
A	XXXXXX	RELEASE	5/9/1957	DR
B	F120091	REDRAWN CAD, WAS C SIZE GROUP DRAWING	9/19/2012	dmjohnson
C	F130052	ROTATE ROCKER CUPS 30 DEG	4/5/2013	dmjohnson

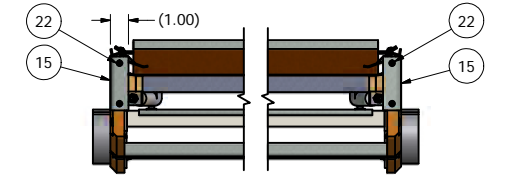
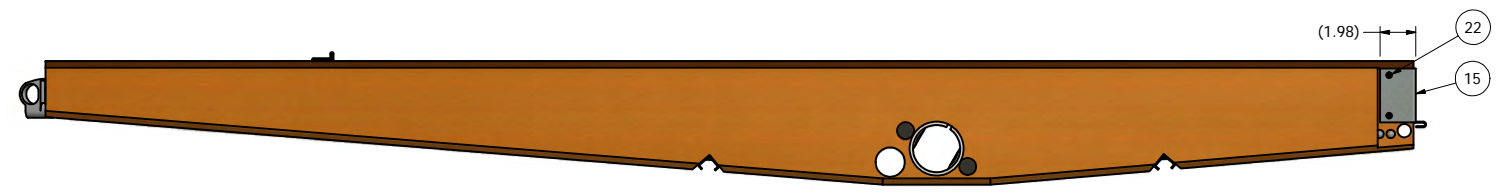
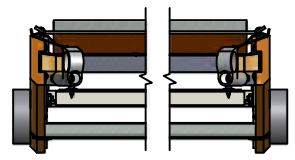
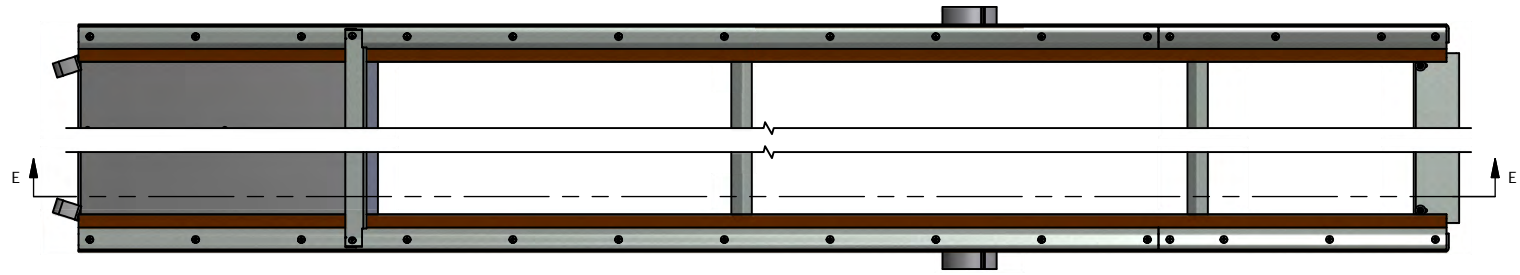

STEP 4: COMPLETE ASSEMBLY, RIGHT SIDE VIEW

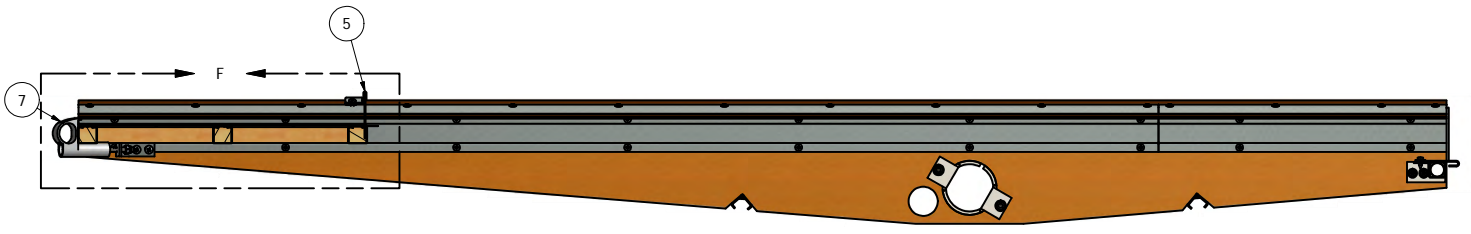

SECTION E-E

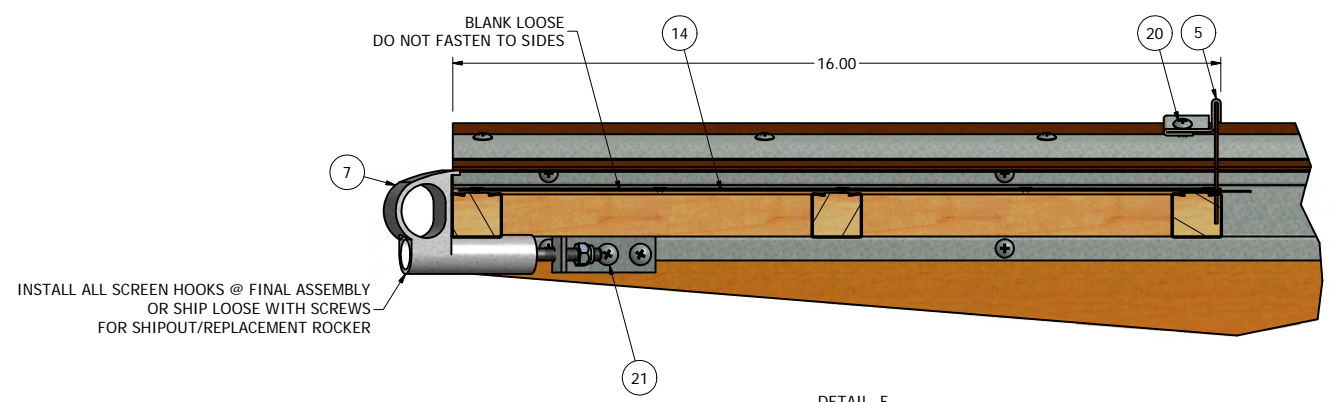

DETAIL F  
SCALE 1/2

ITEM	PART NUMBER	QTY	DESCRIPTION
24	F91152006	13.000 ft	BELTING, 3 PLY FSXFS 2.50 X 78.00"
23	F90005303	1	GIRT WLDMT, ROCKER ADJ, TELESCOPING, #8
22	F84212122	8	SMS, FLT X HD #8 X 3/4"
21	F83453403	4	SMS, PAN X HD, #10 X 3/4"
20	F83453402	68	SMS, PAN X HD, #8 X 3/4"
19	F83451201	7	SMS, PAN X HD, #8 X 1/2"
18	F83440301	4	SMS, FLAT CROSS HEAD #10 X 1.50"
17	F82021407	4	BOLT, ELEV 1/4-20 X 1.25"
16	F11302510	1	COVER, APRON, ADJ GIRT, ROCKER, #8
15	F03806000	2	ANGLE, SCREEN STOP, ROCKER
14	F03803303	1	BLANK ASSY, BTM ROCKER, BTM SHOE, SX298D
13	F03801100	2	CAP, RUBBER HOLDING, ROCKER, 60.00"
12	F03801100	2	CAP, RUBBER HOLDING, ROCKER, 16.00"
11	F03800412	2	LINER WLDMT, SCREENWAY, ROCKER, 76.00"
10	F03800002	2	BRACE, BOTTOM, ROCKER, #8
9	F03601505	1	SIDE, LH, BTM ROCKER 76", BTM SHOE, SX29D/SX298D
8	F03601504	1	SIDE, RH, BTM ROCKER 76", BTM SHOE, SX29D/SX298D
7	F03500800	2	SCREEN HOOK ASSY, STANDARD
6	F03500600	2	CUP WLDMT, ROCKER, HEAVY DUTY BRUSH
5	F03310009	1	GRAIN STOP ASSY, ROCKER, 2.50" X #8
4	66783300	4	NUT, HEX SERR LOCK 1/4-20
3	66782600	4	NUT, HEX SERR LOCK 10-24
2	66402200	7	WASHER, FLAT, #8
1	60282626	4	BOLT, CARR 10-24 X 1.25"

**CLIPPER**  
SEPARATION TECHNOLOGIES  
SINCE 1988

**DIVISION OF**  
A.T.FERRELL COMPANY  
1440 S ADAMS ST  
BLUFFTON, INDIANA  
46714 - USA  
PH: 260-824-3400  
FAX: 260-824-5463

This drawing is the property of the A.T. Ferrell Company, Inc and must be returned immediately upon request. No part of this drawing may be reproduced, stored in a retrieval system or transmitted in any form or by any means, without prior written consent of the A.T. Ferrell Company, Inc.

TOLERANCES EXCEPT AS NOTED		TITLE:	
DECIMAL: XX ± .030	FRACTIONAL: ± 1/32	ROCKER ASSY, BOTTOM, BOTTOM SHOE, SX298D	
XXX ± .005	ANGULAR: ± 1/2°	FINISH:	
XXXX ± .001		NONE	
<b>CAD</b>	NO MANUAL CHANGES	SCALE: 0.19:1	SHEET: 3 OF 3
		SIZE: D	PART NUMBER: F03502010
			REV: C

- NOTES:
- DO NOT SCALE FROM DRAWING.
  - ONE PIECE REQUIRED PER F03013208/09: SHOE ASSY, RH/LH ADJ PITCH BOTTOM, SX298D.
  - ONE PIECES REQUIRED PER F03018407/08: SHOE ASSY, RH/LH ADJ PITCH BOTTOM, SX298D.